

# Piezo Speaker

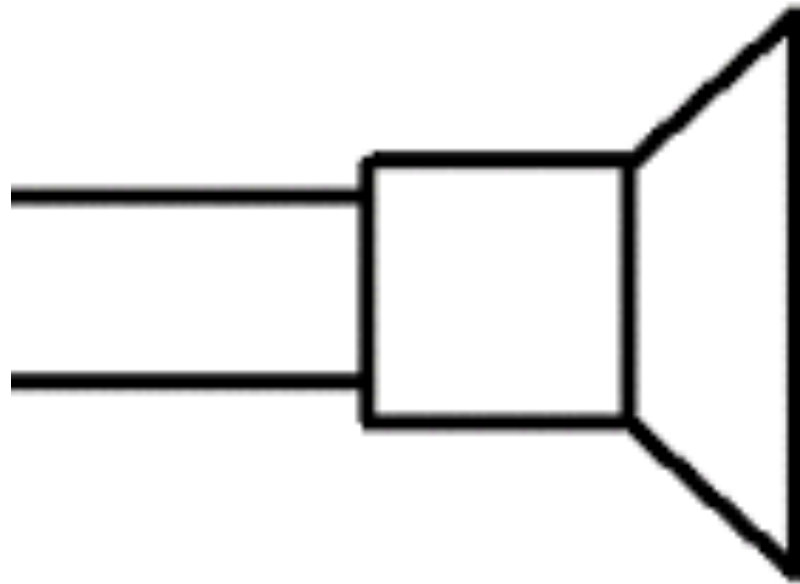

# Battery

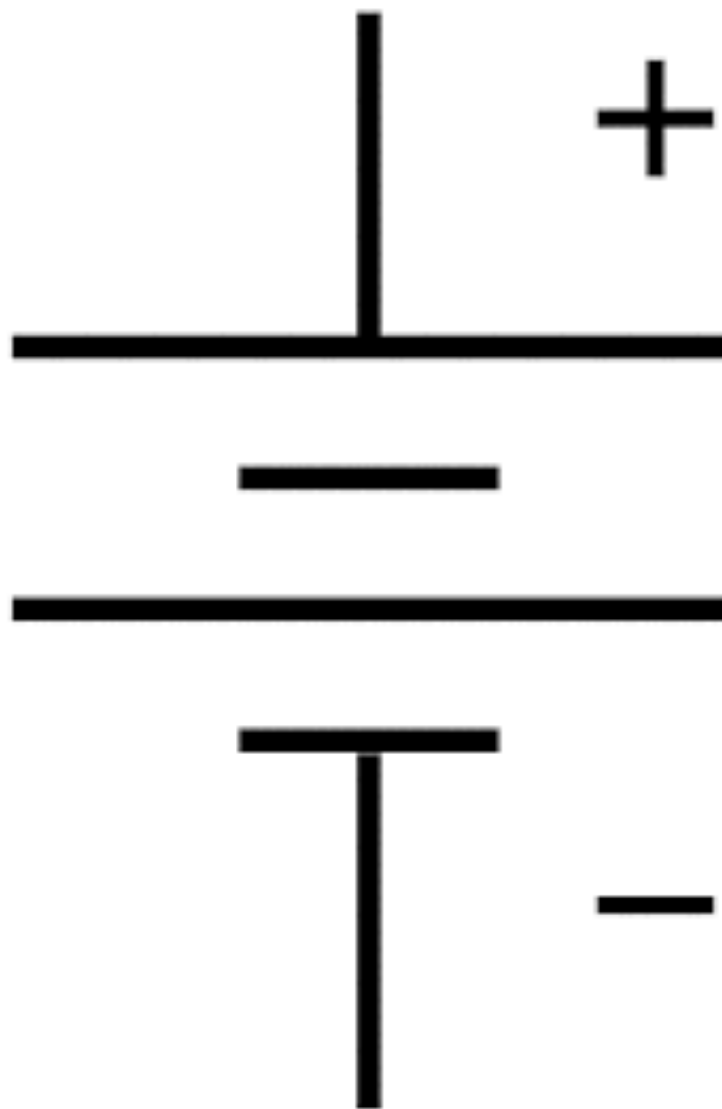

# Knife Switch



SPDT

# Momentary Switch



**LED**

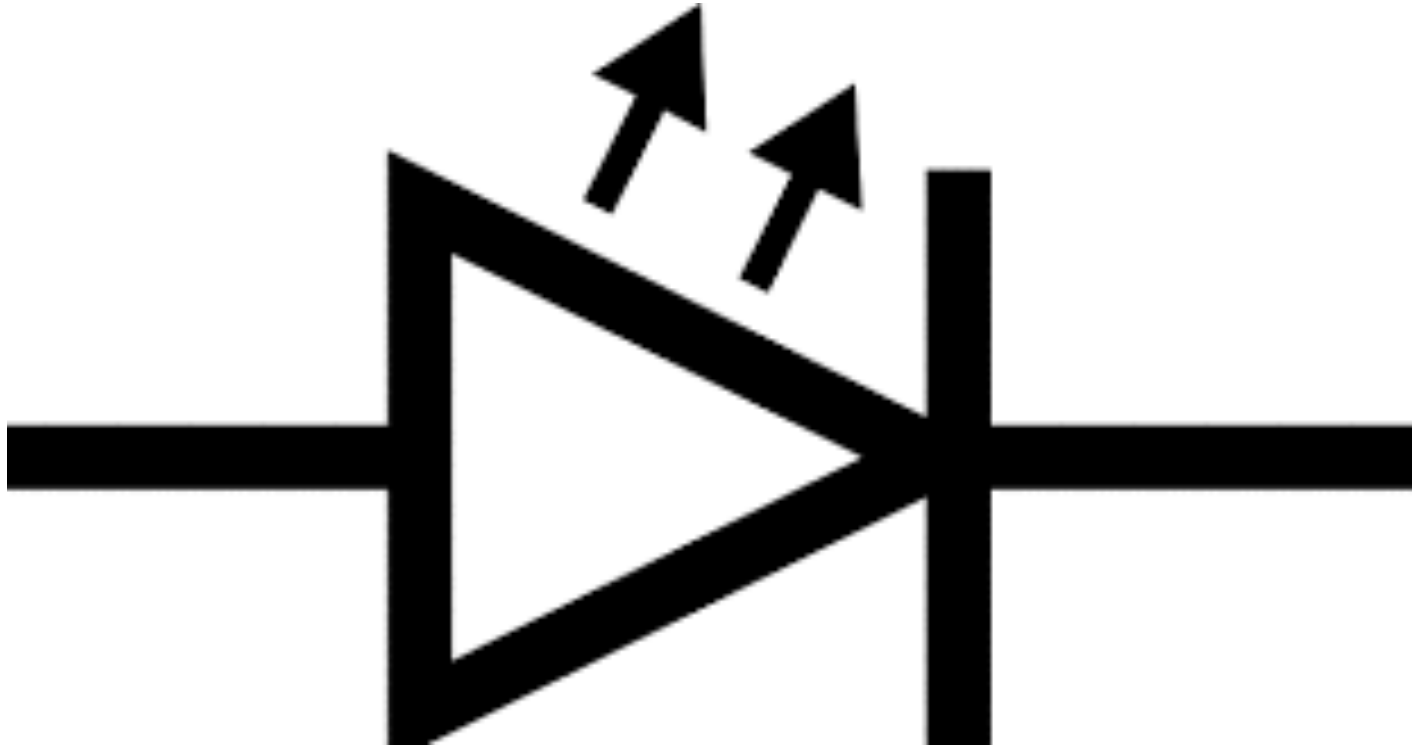

# Motor

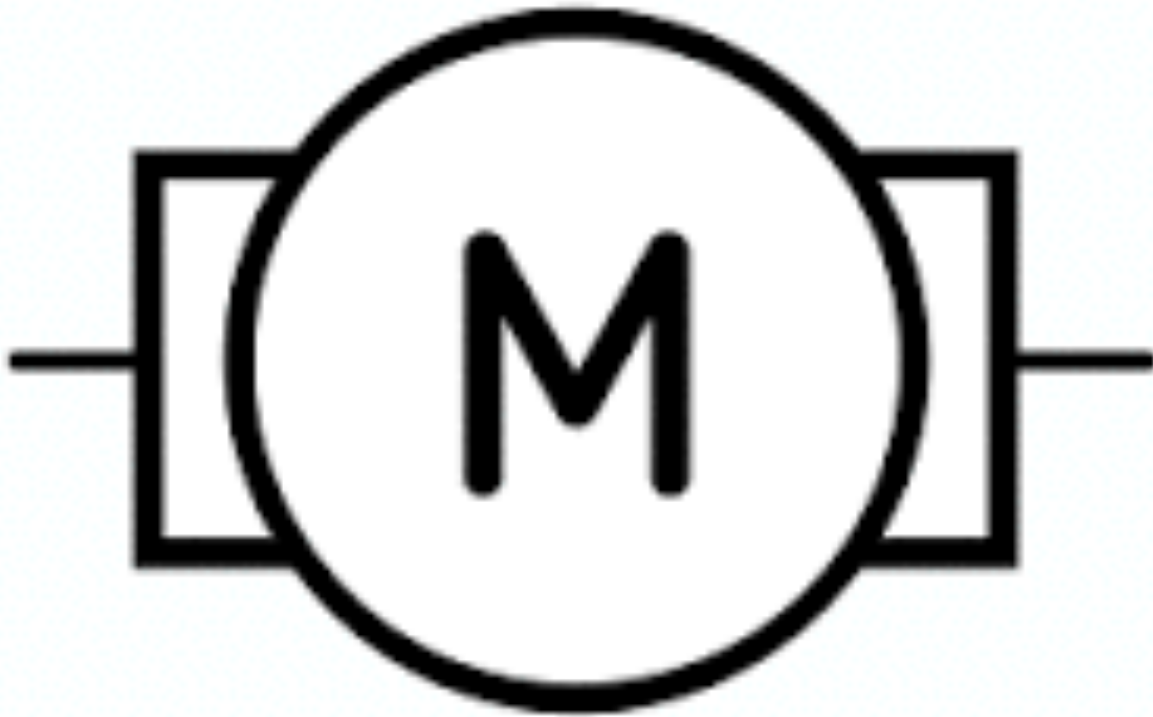

# Potentiometer



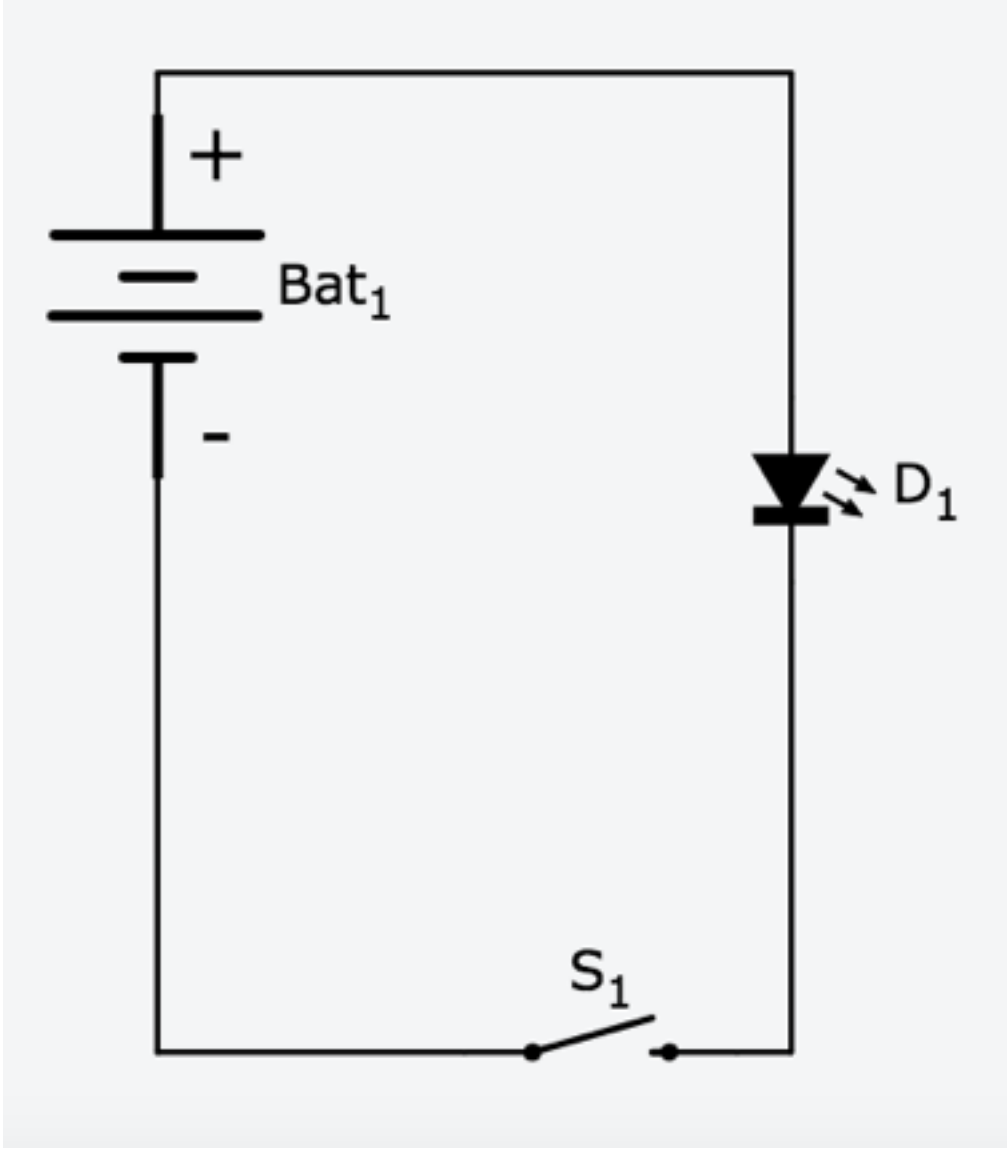



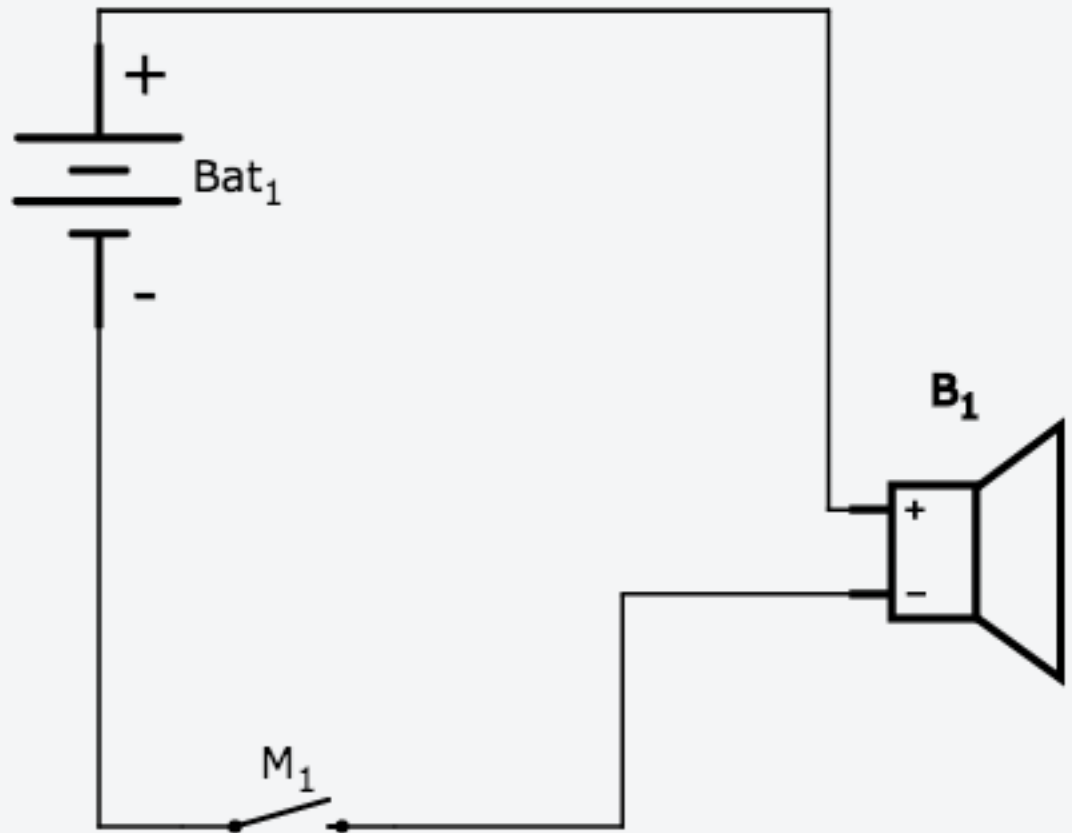

# RGB LED

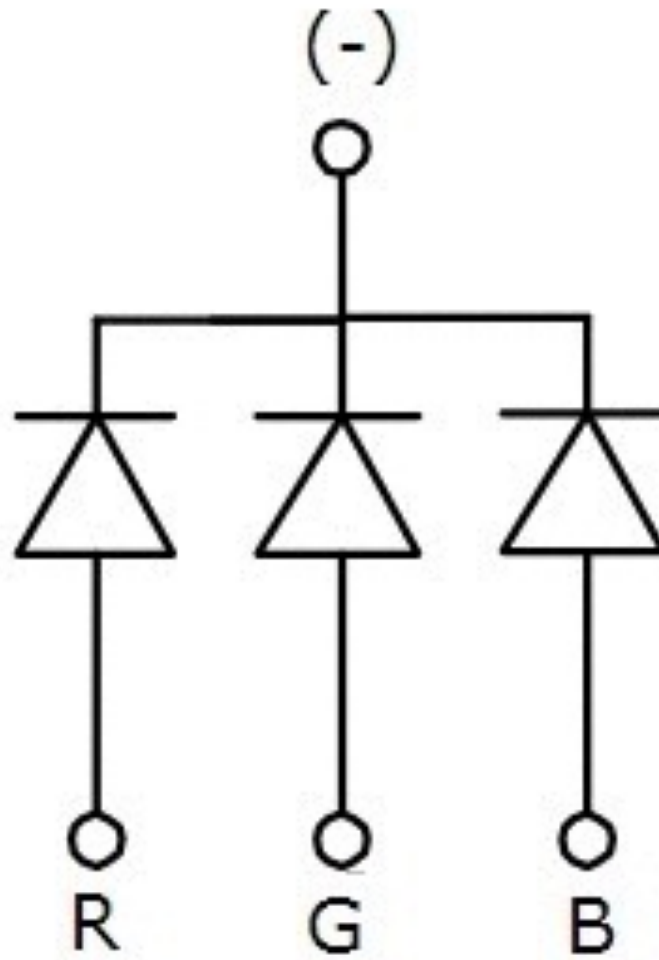

.

