

Recording the Scare Sound

The PicoBoo can store a total of two minutes of sound that will playback during your scare.

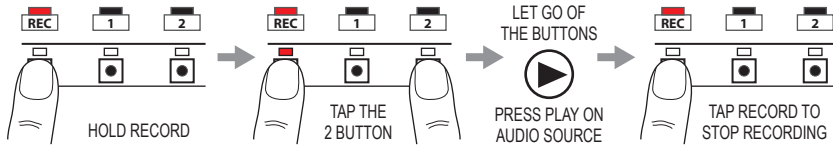

Previewing the Scare Sound

Press the 2 button to preview your Scare sound. You can let it play through or press it again to cancel playback.

Multiple Scare Sounds

The PicoBoo can store up to ten scare sounds, as long as they are under two minutes (see online manual).

Ambient Sound

The PicoBoo can also record an Ambient sound that it will loop while it waits to be triggered. An Ambient sound must be recorded **before** the Scare sound. To record or preview the Ambient sound, follow the steps above using the 1 button instead of the 2 button. Once you're happy with the Ambient sound you may record the Scare sound, as long as they are under two minutes. To disable the Ambient sound, record silence for less than three seconds.

Recording Animation

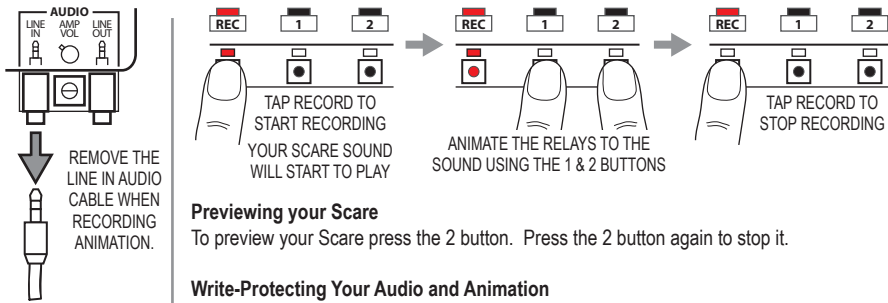

Previewing your Scare

To preview your Scare press the 2 button. Press the 2 button again to stop it.

Write-Protecting Your Audio and Animation

The write-protect setting can be toggled on or off by powering up the PicoBoo while holding the 2 button. When the red light flashes a few times the write-protect has been toggled.

Troubleshooting

The REC light keeps flashing

The input is probably set to normally-closed when it should be normally-open. To change it back, power up the PicoBoo while holding the 1 button. Let go of the button when you see the REC light blink a few times.

The REC button is not responding. Can't record audio or animation.

- The PicoBoo may be write-protected. See *Write-Protecting Your Audio and Animation* above.
- If it's animation you can't record, make sure there is no audio cable in the PicoBoo's Line In jack.

The sound starts cutting out or sounds crackly

- If you're NOT using the amplified output you may have recorded at too high a volume. Try re-recording the audio with the audio source set to a lower volume.
- If you're using the amplified output your power supply may be too small. Try turning down the volume or swapping out the power supply with one that has a higher current or wattage rating. If the audio clicks or pops when you turn an output off you may need diodes or capacitors on your solenoids. See the full manual for more details.

Don't see your problem here? Check our website for more information.



Quick-Start Guide

PicoBoo



NEED HELP?

There are videos, a full manual, and more diagrams available online.

Power Supply

POWER CAN BE SUPPLIED USING THE BARREL CONNECTOR OR THE TRIGGER TERMINAL BLOCK.

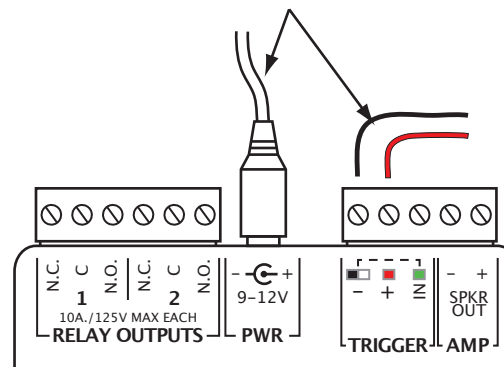

Sizing your Power Supply

Your PicoBoo's power supply must be 12 volts DC. The wattage you'll need depends on whether you're using the internal amp, and if you're trying to power other devices from the same supply.

Add up the wattage of all the devices that will be used at the same time and make sure your power supply's wattage is equal to or higher than that number. Use 2 watts for the PicoBoo if you're not using the amp, and 12 if you are.

Example:

12 watts PicoBoo and internal amp
 + 12 watts 2 x 12VDC 6 watt solenoids
 = 24 watts Total - Need at least 24 watts

Amplified Speaker Output

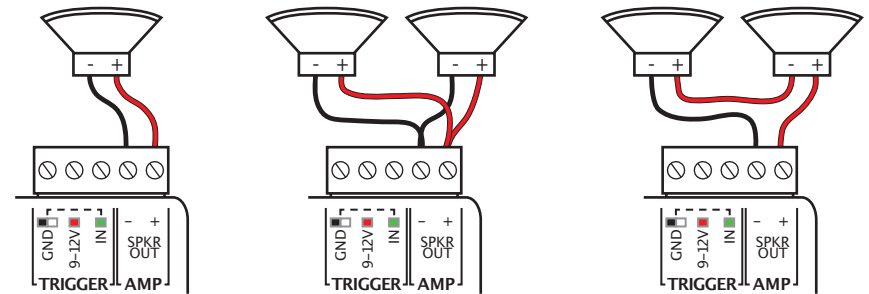

ONE 4, 8, OR 16 OHM SPEAKER

TWO 8 OR 16 OHM SPEAKERS

TWO 4 OHM SPEAKERS

Relay Output Wiring

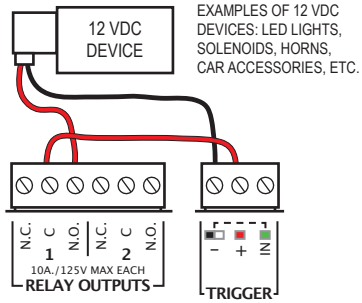

ANY 12 VDC DEVICE

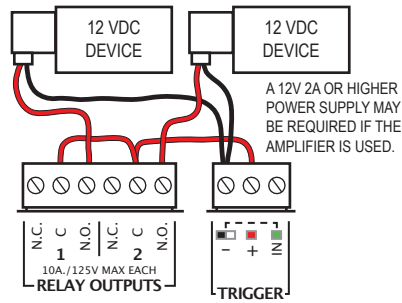

TWO 12 VDC DEVICES

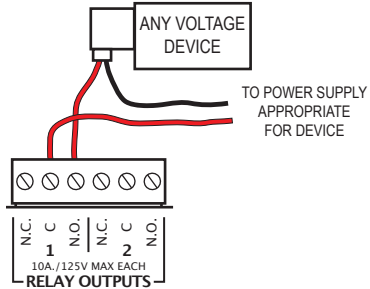

ANY DEVICE THAT'S NOT 12 VDC

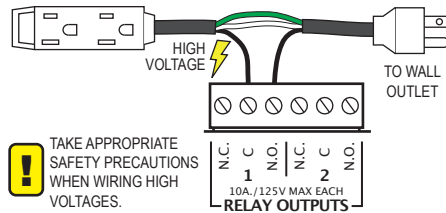

ANY 110 VOLT LOAD

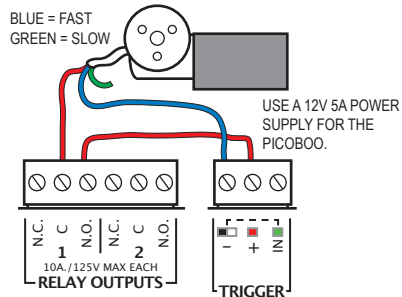

12 VDC MOTOR ON/OFF IN ONE DIRECTION

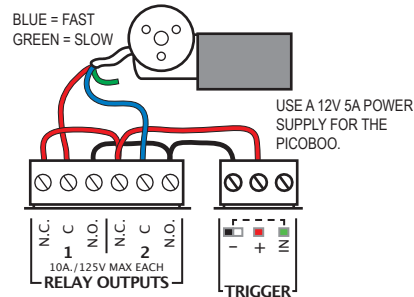

12 VDC MOTOR FORWARD AND REVERSE

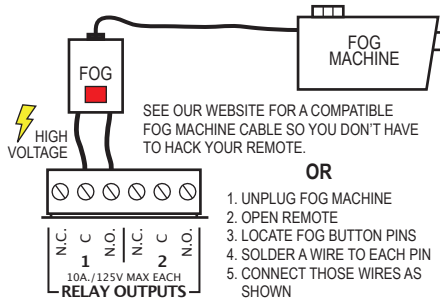

FOG MACHINE

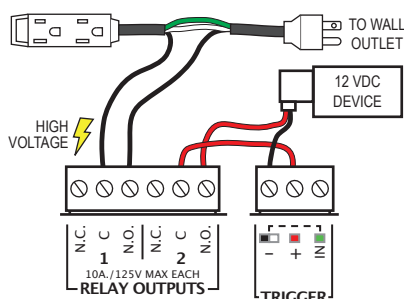

ONE 110 VOLT DEVICE, ONE 12 VDC DEVICE

Trigger Input Wiring

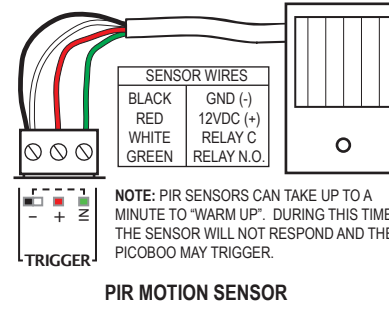

PIR MOTION SENSOR

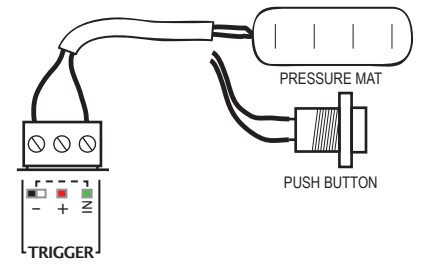

PRESSURE MAT OR PUSHBUTTON

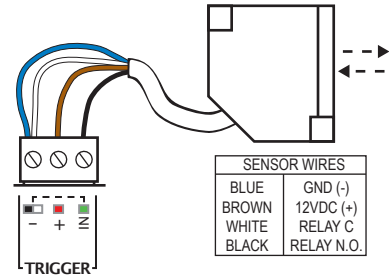

BEAM SENSOR

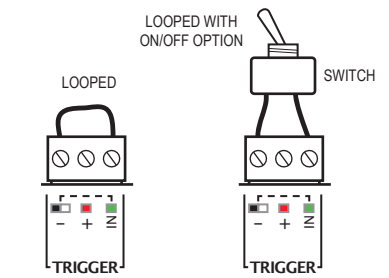

CONTINUOUS PLAY (LOOPED)

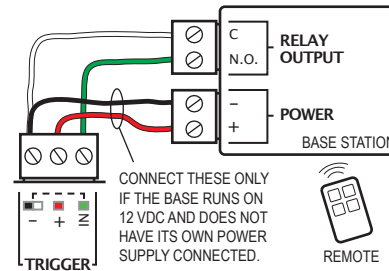

WIRELESS TRIGGER

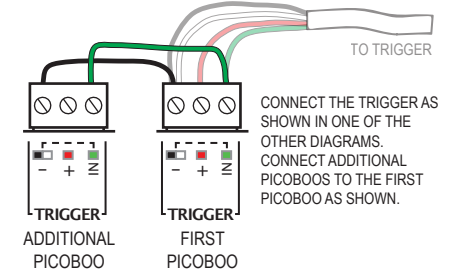

MULTIPLE PICOBOOS WITH ONE TRIGGER

Recording Audio

Connect Audio Source and Speakers

