

**TENSIONER PULLEY (1), 1/8" THICK WOOD**

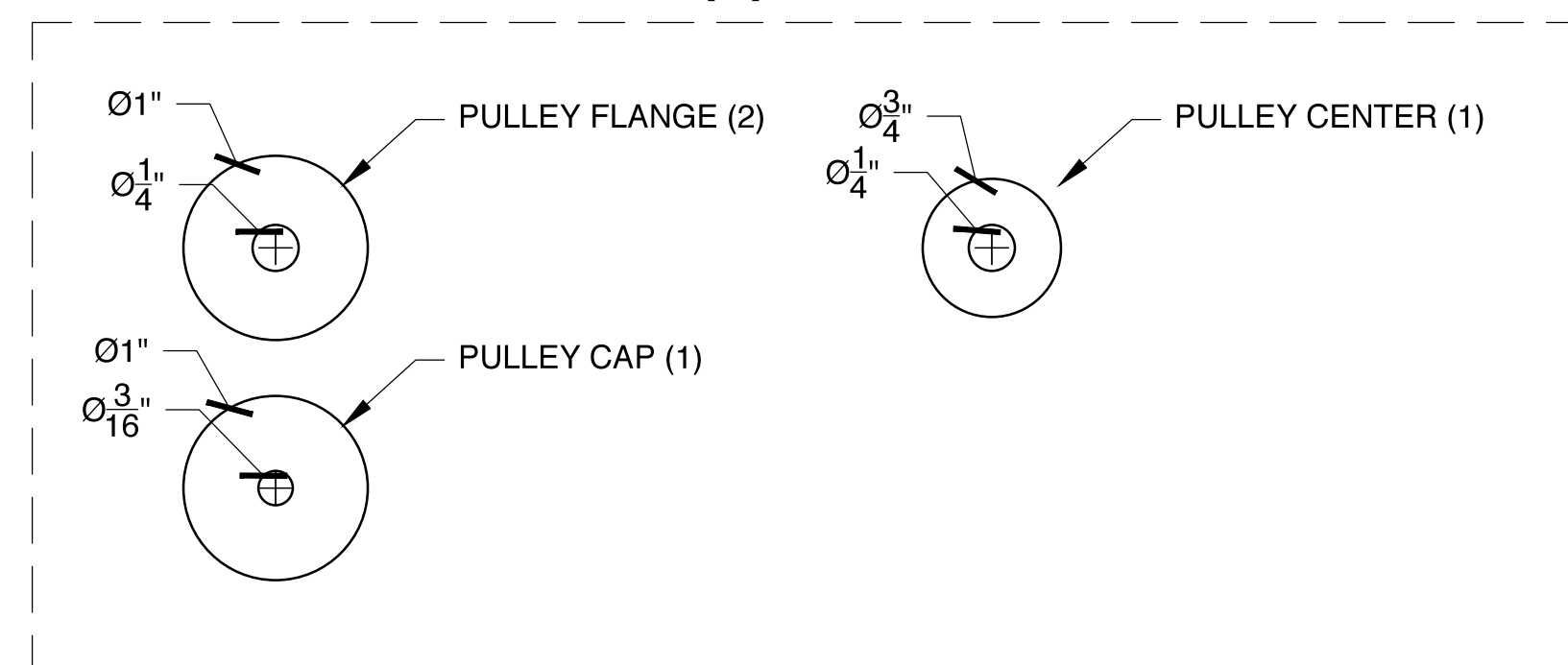

**CRANKS (2), 1/2" THICK WOOD**

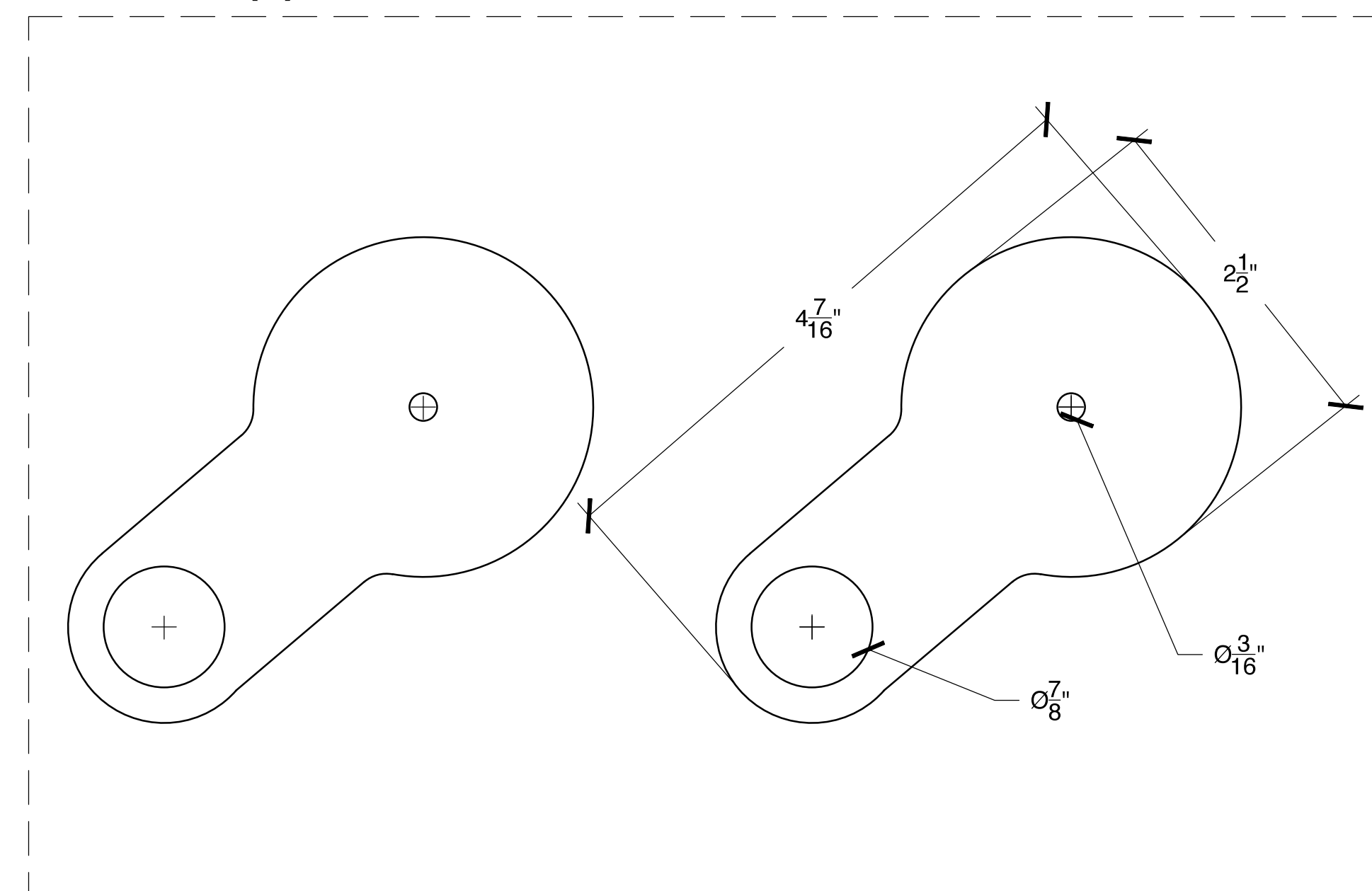

**DOWELS**

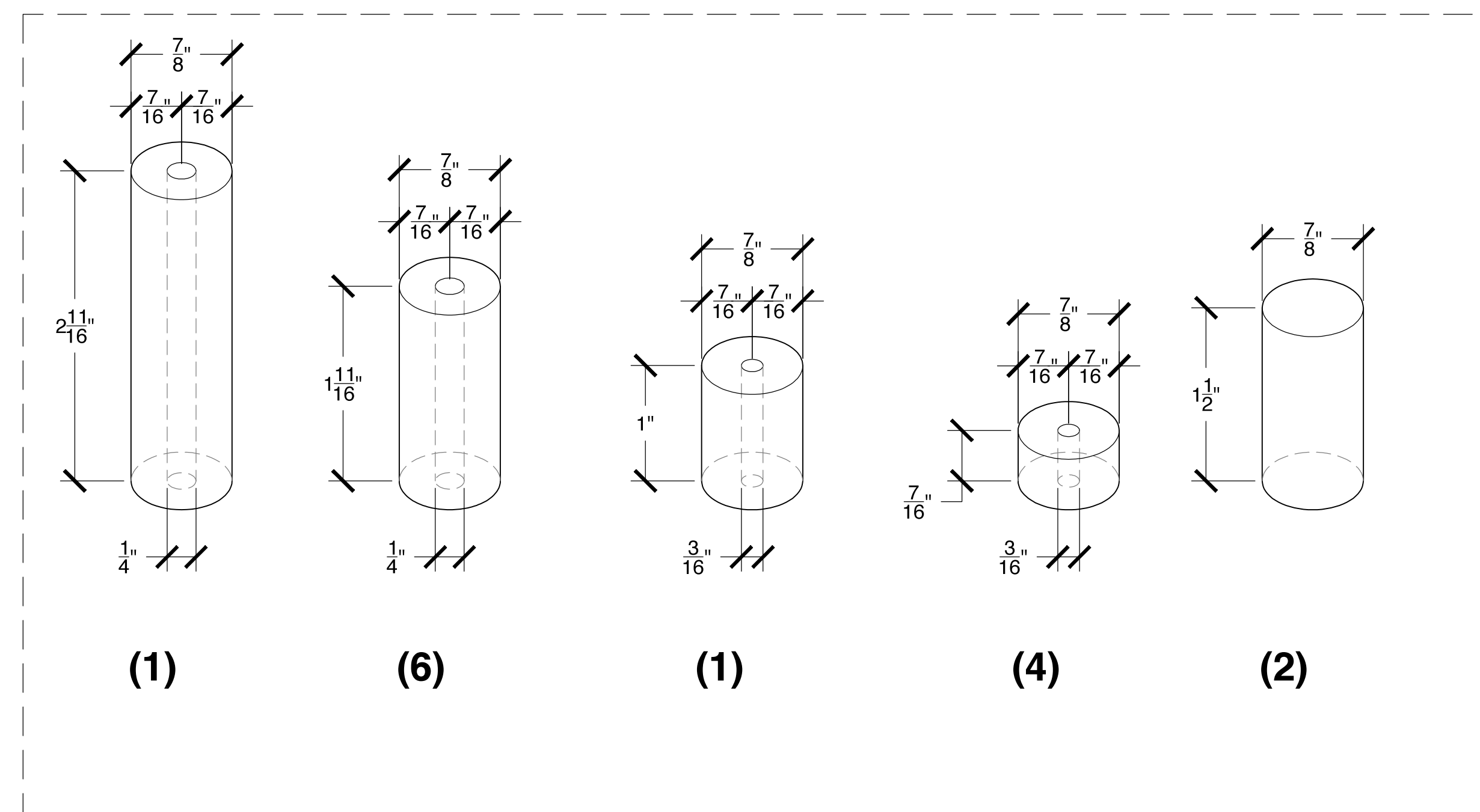

**DRIVER PULLEYS (2), 1/4" THICK RUBBER**

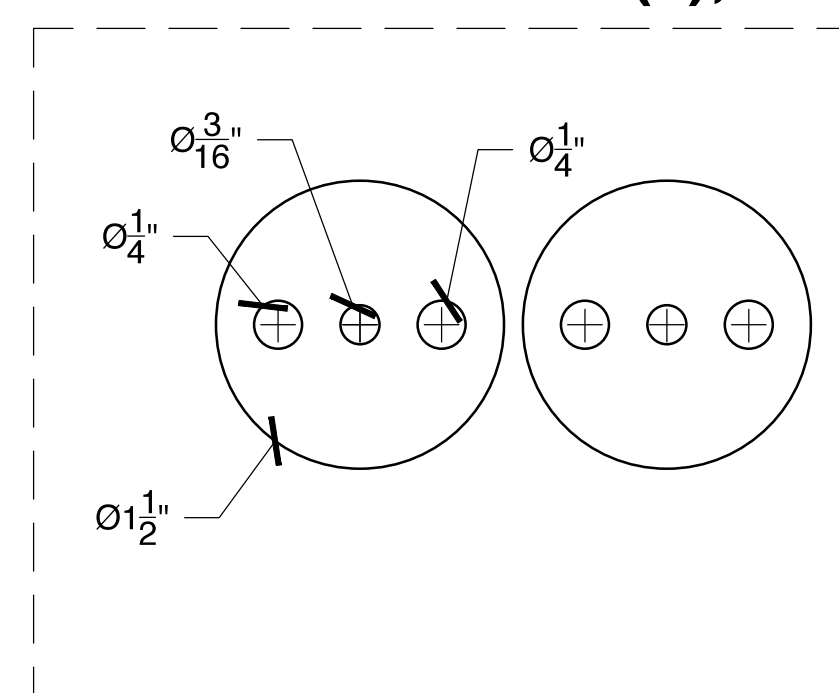

**DRIVER PULLEYS (2), 1/8" THICK WOOD**

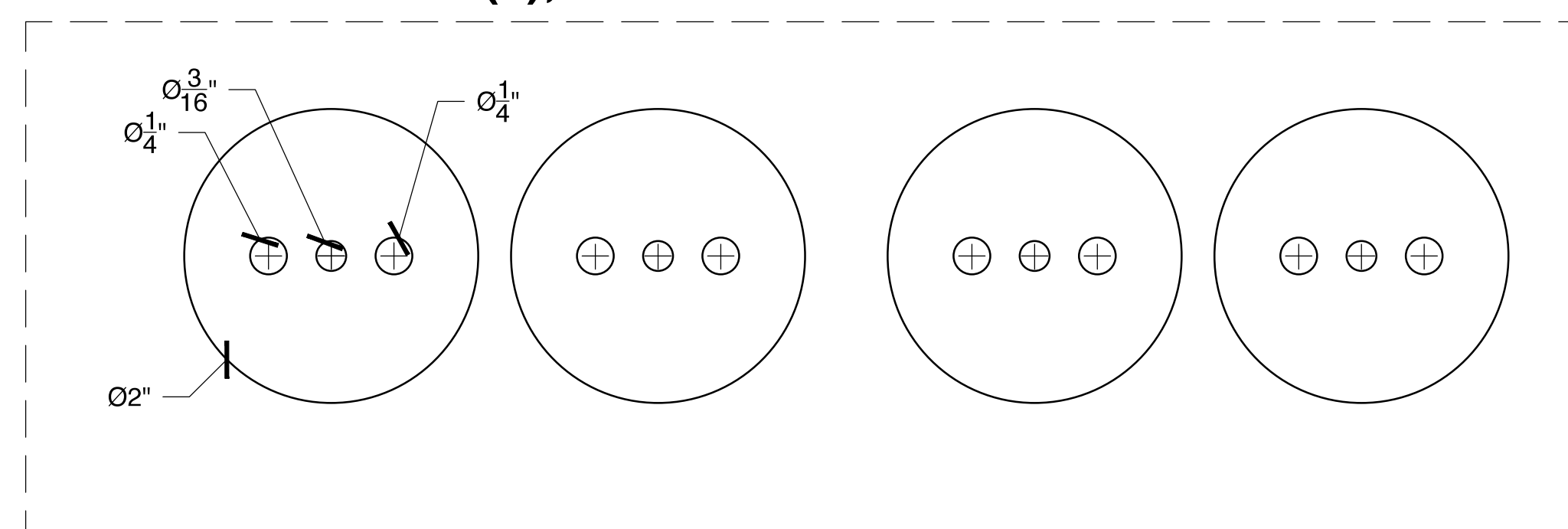

**STANDARD PULLEYS (8), 1/8" THICK WOOD**

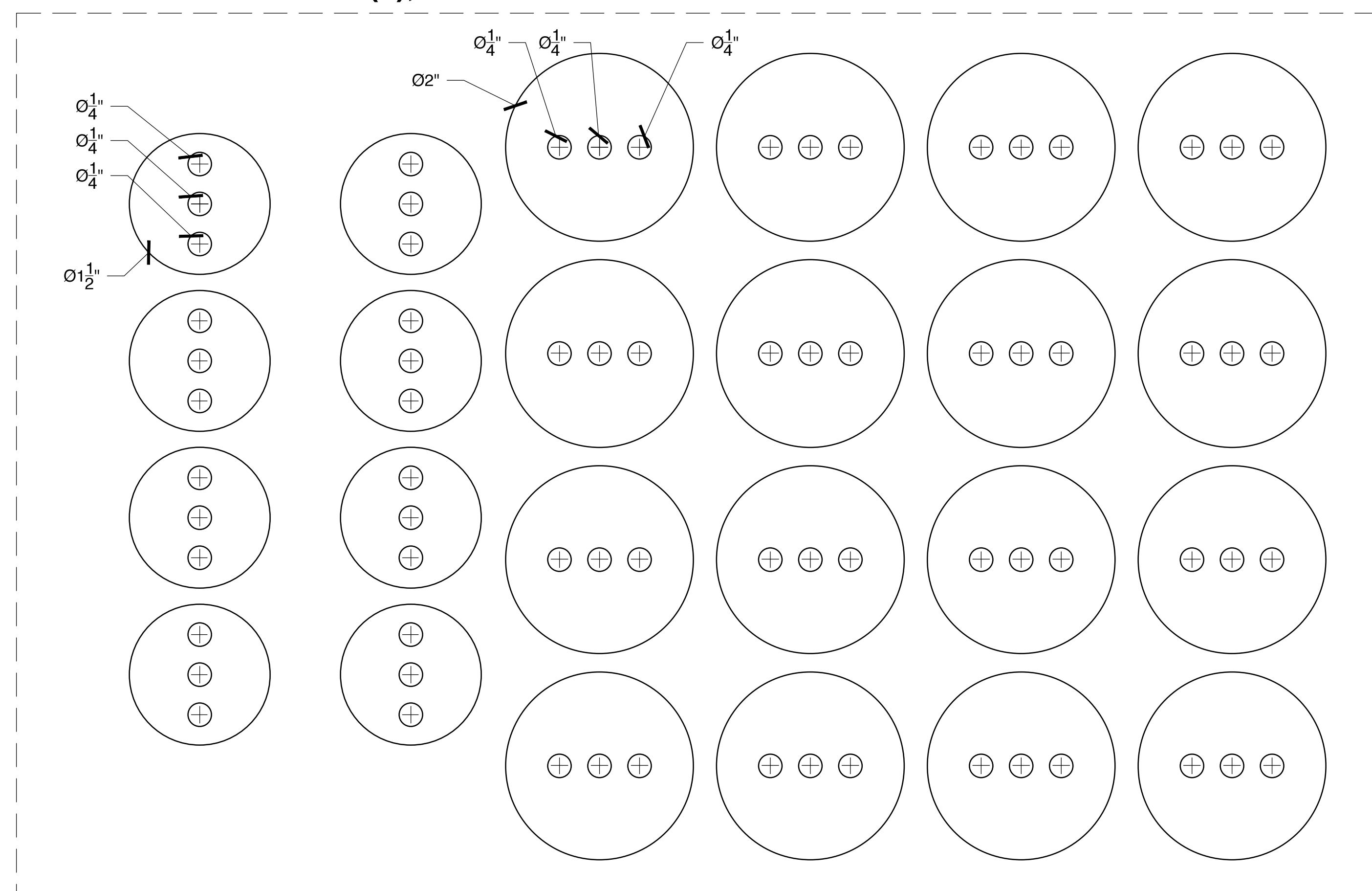

**AXLE CAPS (2 EA), 1/8" THICK WOOD**

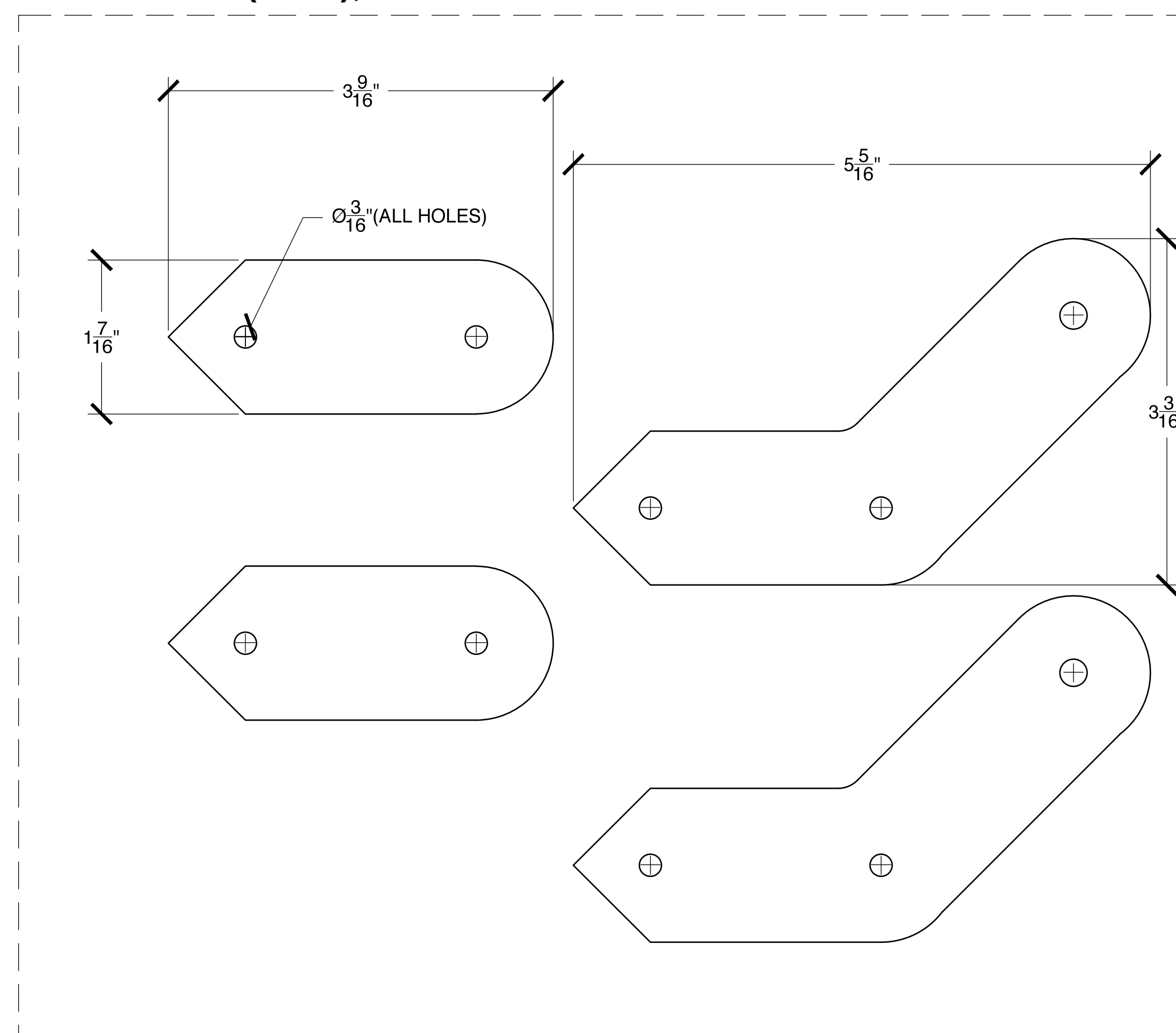

**TO USE AS TEMPLATE, PRINT AT FULL SCALE (100%) ON 24"X36" (ARCH D) PAPER**

**TRAY SIDES (2 EA), 1"X3/4"**

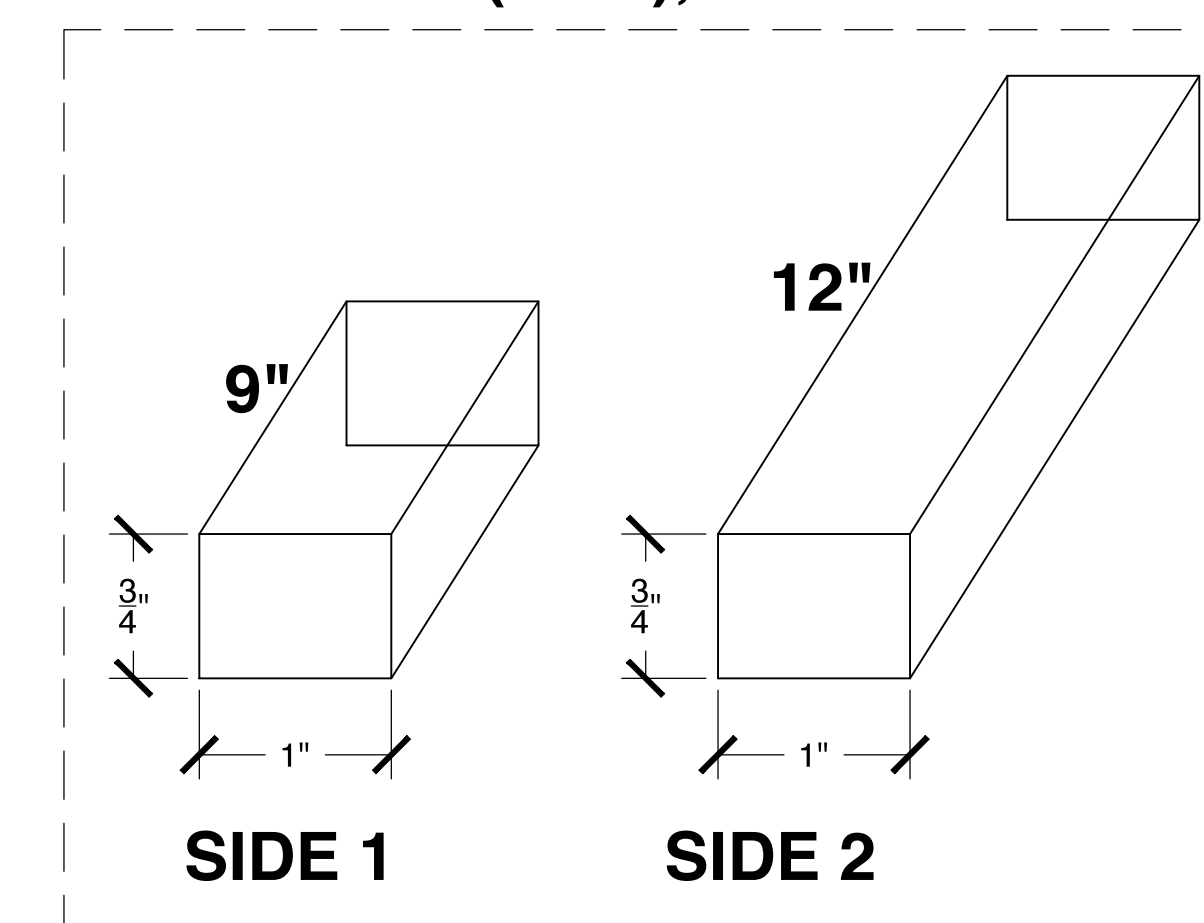

**TRAY SIDES (4), 1"X1"X2 1/2"**

