

SML400HB06

Attributes:

- aerospace build standard
- high reliability
- lightweight
- metal matrix base plate
- AlN isolation

**Maximum rated values/
Electrical Properties**

Collector-emitter Voltage		V_{ce}	600	V
DC Collector Current	$T_c=70C, T_{vj}=175C$ $T_c=25C, T_{vj}=175c$	$I_{c, nom}$ I_c	400 500	A
Repetitive peak Collector Current	$t_p=1msec, T_c=80C$	I_{crm}	800	A
Total PowerDissipation	$T_c=25C$	P_{tot}	850	W
Gate-emitter peak voltage		V_{ges}	+/-20	V
DC Forward Diode Current		I_f	400	A
Repetitive Peak Forward Current	$t_p=1msec$	I_{frm}	800	A
I^2t value per diode	$V_r=0V, t_p=10msec,$ $T_{vj}=125C$ $T_{vj}=150C$	I_t^2	11000 10500	A^2sec
Isolation test voltage	RMS, 50Hz, $t=1min$	V_{isol}	2500	V

Collector-emitter saturation voltage	$I_c=400A, V_{ge}=15V, T_c=25C$ $I_c=400A, V_{ge}=15V, T_c=125C$ $I_c=400A, V_{ge}=15V, T_c=150C$	$V_{ce(sat)}$		1.55 1.6 1.7	1.9	V
Gate Threshold voltage	$I_c=6.4mA, V_{ce}=V_{ge}, T_{vj}=25C$	$V_{ge(th)}$	4.9	5.8	6.5	V
Input capacitance	$f=1MHz, T_{vj}=25C, V_{ce}=25V,$ $V_{ge}=0V$	C_{ies}		26		nF
Reverse transfer Capacitance	$f=1MHz, T_{vj}=25C, V_{ce}=25V,$ $V_{ge}=0V$	C_{res}		0.76		nF
Collector emitter cut off current	$V_{ce}=600V, V_{ge}=0V, T_{vj}=25C$ $V_{ce}=600V, V_{ge}=0V, T_{vj}=125C$	I_{ces}		1 1	5	mA mA
Gate emitter cut off current	$V_{ce}=0V, V_{ge}=20V, T_{vj}=25C$	I_{ges}			400	nA



Turn on delay time	Ic=400A, Vcc=300V Vge=+/-15V, Rg=1.5Ω, Tvj=25C Vge=+/-15V, Rg=1.5Ω, Tvj=125C Vge=+/-15V, Rg=1.5Ω, Tvj=150C	t _{d,on}	110 120 130	nsec nsec nsec
Rise time	Ic=400A, Vcc=300V Vge=+/-15V, Rg=1.5Ω, Tvj=25C Vge=+/-15V, Rg=1.5Ω, Tvj=125C Vge=+/-15V, Rg=1.5Ω, Tvj=150C	t _r	50 60 60	nsec nsec nsec
Turn off delay time	Ic=400A, Vcc=300V Vge=+/-15V, Rg=1.5Ω, Tvj=25C Vge=+/-15V, Rg=1.5Ω, Tvj=125C Vge=+/-15V, Rg=1.5Ω, Tvj=150C	t _{d,off}	490 520 530	nsec nsec nsec
Fall time	Ic=400A, Vcc=300V Vge=+/-15V, Rg=1.5Ω, Tvj=25C Vge=+/-15V, Rg=1.5Ω, Tvj=125C Vge=+/-15V, Rg=1.5Ω, Tvj=150C	t _f	50 70 70	nsec nsec nsec
Turn energy loss per pulse	Ic=400A, Vce=300V, Vge=15V Rge=1.5Ω, L=30nH Tvj=125C Tvj=150C	E _{on}	3.2 3.4	mJ mJ
Turn off energy loss per pulse	Ic=400A, Vce=300V, Vge=15V Rge=1.5Ω, L=30nH Tvj=125C Tvj=150C	E _{off}	15 15.5	mJ mJ
SC Data	tp≤10μsec, Vge≤15V Vce=360V, Tvj=25C Vce(max)=Vces-L di/dt Tvj=150C	I _{sc}	2800 2000	A A
Stray Module inductance		L _{σce}	40	nH
Terminal-chip resistance		R _c	1.2	mΩ

Diode characteristics

Forward voltage	Ic=400A, Vge=0V, Tc=25C Ic=400A, Vge=0V, Tc=125C Ic=400A, Vge=0V, Tc=150C	V _f	1.55 1.5 1.4	1.9 V V V
Peak reverse recovery current	If=400A, -di/dt=7000A/μsec Vce=300V, Vge=-10V, Tvj=25C Vce=300V, Vge=-10V, Tvj=125C Vce=300V, Vge=-10V, Tvj=150C	I _{rm}	270 330 350	A A A
Recovered charge	If=400A, -di/dt=7000A/μsec Vce=600V, Vge=-10V, Tvj=25C Vce=600V, Vge=-10V, Tvj=125C Vce=600V, Vge=-10V, Tvj=150C	Q _r	15 29 32	μC μC μC
Reverse recovery energy	If=400A, -di/dt=7000A/μsec Vce=600V, Vge=-10V, Tvj=25C Vce=600V, Vge=-10V, Tvj=125C Vce=600V, Vge=-10V, Tvj=150C	E _{rec}	3.6 7.4 8.3	mJ mJ mJ



Thermal Properties

			Min	Typ	Max	
Thermal resistance junction to case	Igbt Diode	$R_{\theta J-C}$			0.09 0.1	K/W
Thermal resistance case to heatsink		$R_{\theta C-HS}$		0.03		K/W
Maximum junction temperature		T_{vj}			175	C
Maximum operating temperature		T_{op}	-55		175	C
Storage Temperature		T_{stg}	-55		175	C

output characteristic IGBT inverter (typical)
 $I_C = f(V_{CE})$
 $V_{GE} = 15 V$

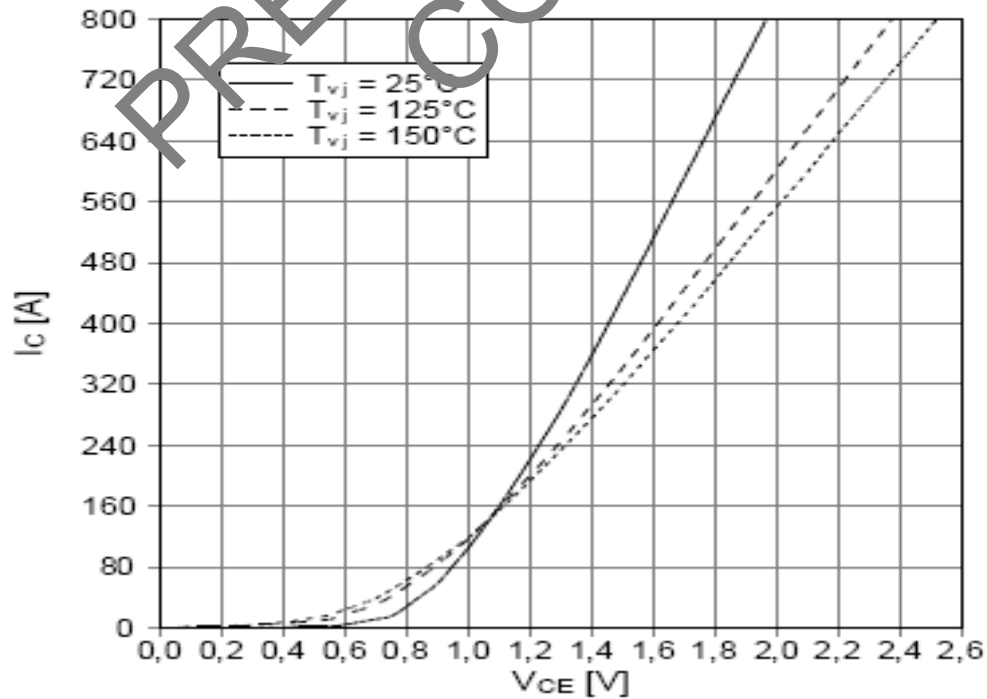



output characteristic IGBT-inverter (typical)

$$I_C = f(V_{GE})$$

$$T_{vj} = 150^{\circ}\text{C}$$

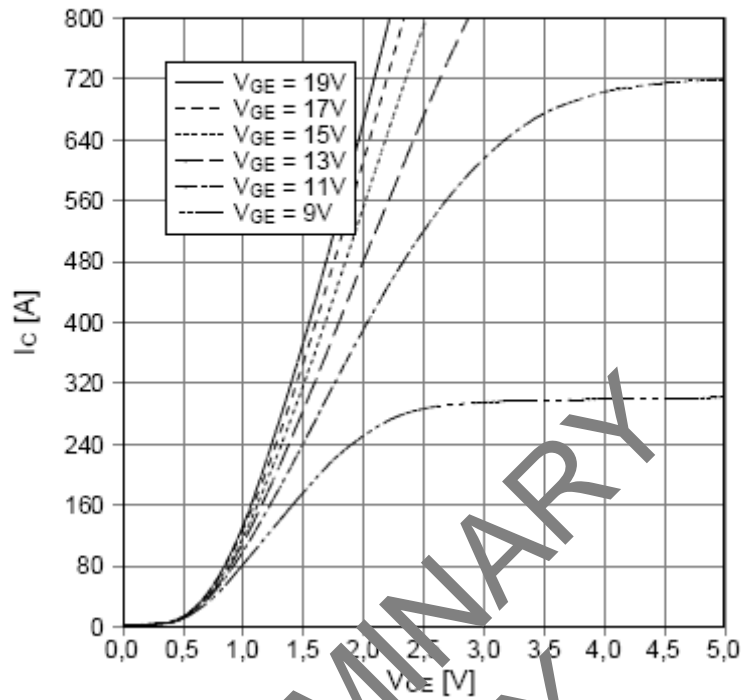

transfer characteristic IGBT-inverter (typical)

$$I_C = f(V_{GE})$$

$$V_{CE} = 20\text{ V}$$

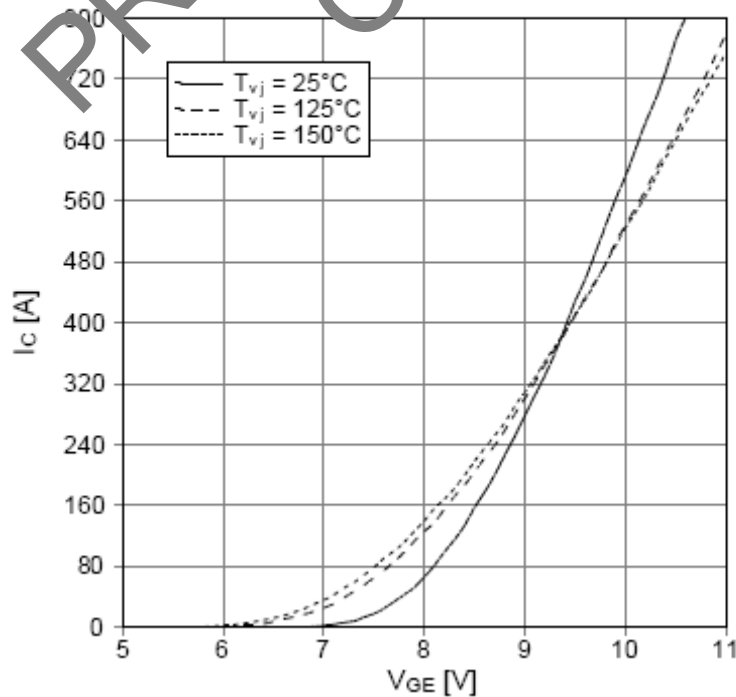



switching losses IGBT-inverter (typical)

$$E_{on} = f(I_c), E_{off} = f(I_c)$$

$$V_{GE} = \pm 15 \text{ V}, R_{Gon} = 1,5 \Omega, R_{Goff} = 1,5 \Omega, V_{CE} = 300 \text{ V}$$

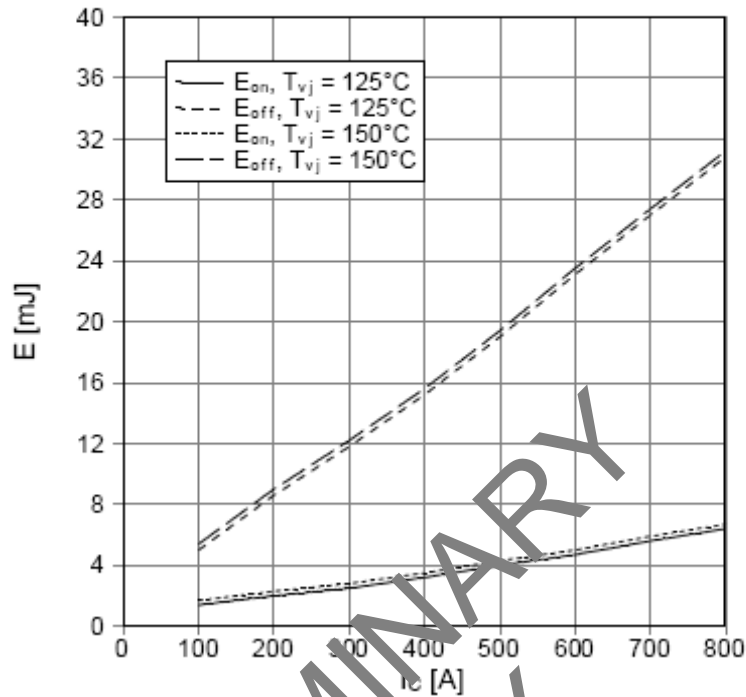

switching losses IGBT Inverter (typical)

$$E_{on} = f(R_G), E_{off} = f(R_G)$$

$$V_{GE} = \pm 15 \text{ V}, I_c = 400 \text{ A}, V_{CE} = 300 \text{ V}$$

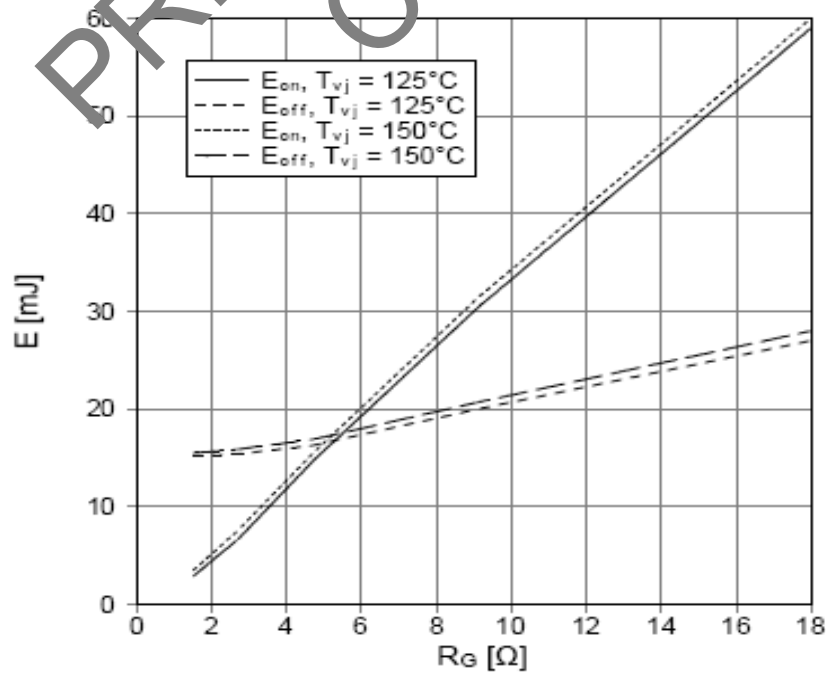



reverse bias safe operating area IGBT-inv. (RBSOA)

$$I_C = f(V_{CE})$$

$$V_{CE} = \pm 15 \text{ V}, R_{\theta Jc} = 1,5 \Omega, T_{vj} = 150^\circ\text{C}$$

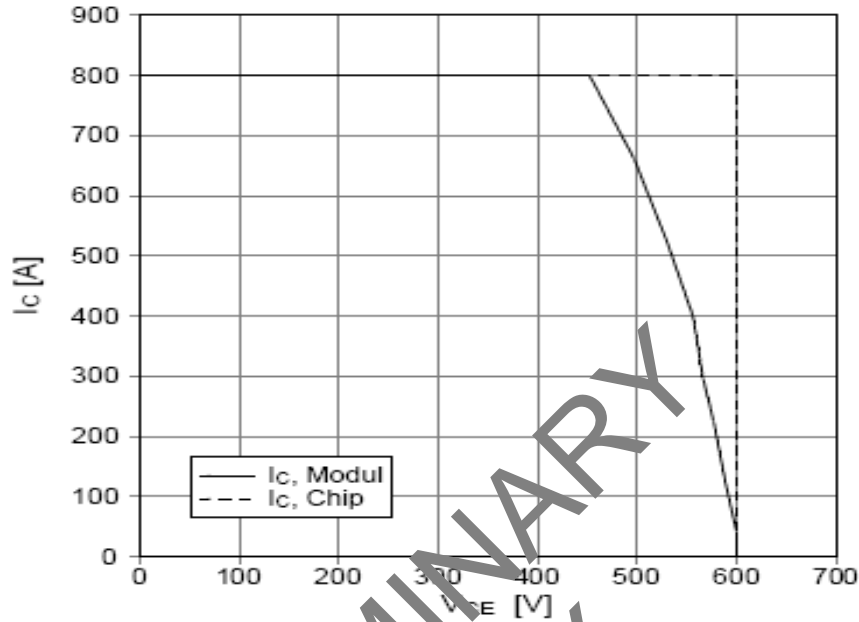

forward characteristic of diode inverter (typical)

$$I_F = f(V_F)$$

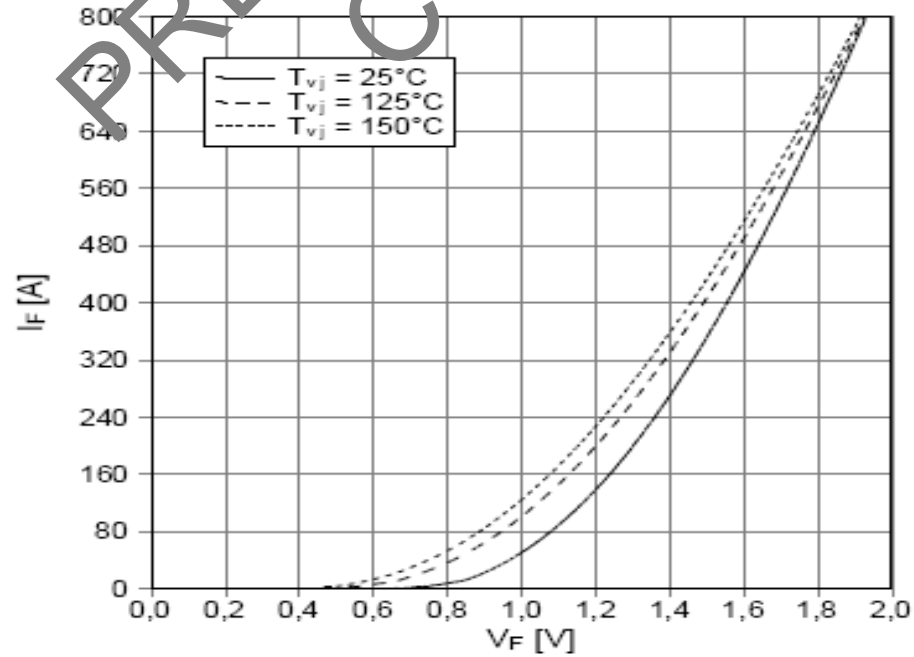

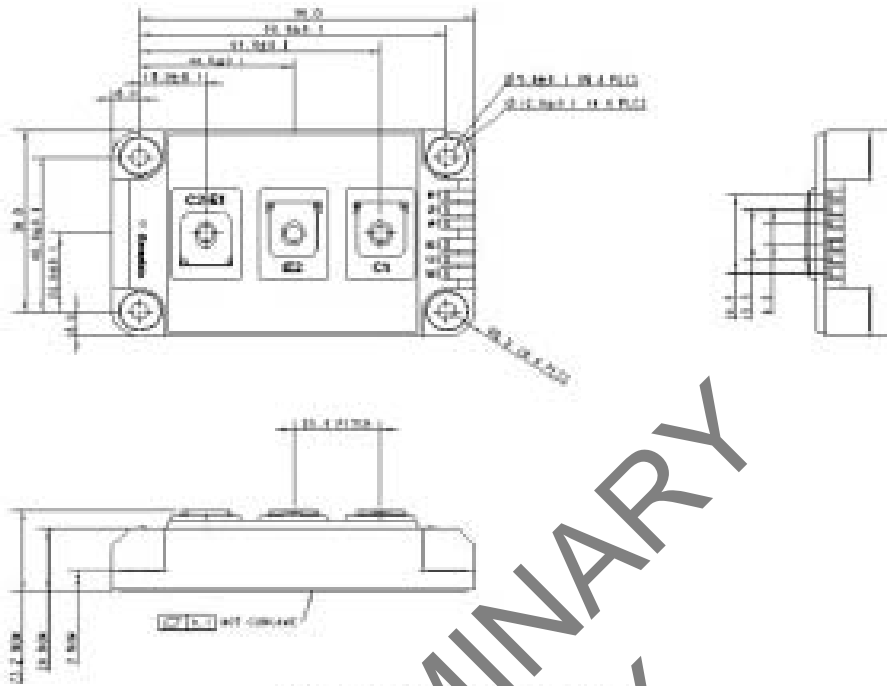

All dimensions in mm

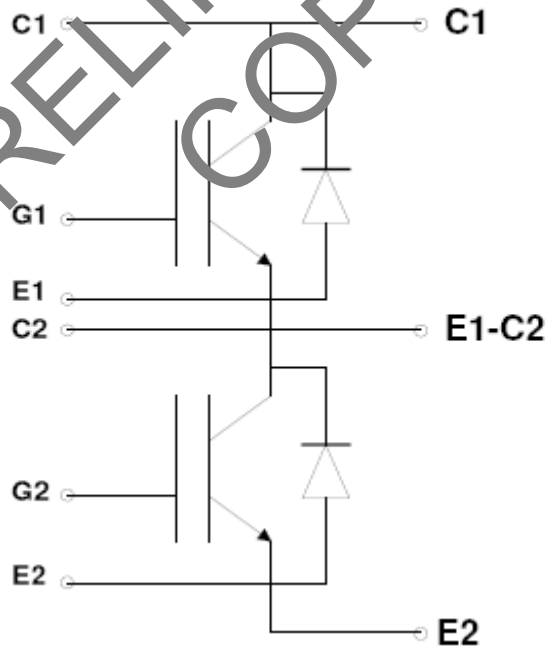

CIRCUIT DIAGRAM